

AVerMedia® **AVerTV™ Box3**

User's Manual



AVerMedia®
EXTERNAL TV TUNER BOX

FCC NOTICE

This device has been tested and found to comply with the limits for a Class B digital device, pursuant to Part 15 of the FCC Rules. These limits are designed to provide reasonable protection against harmful interference in a commercial, industrial or business environment. This equipment can generate, use and radiate radio frequency energy and, if not installed and used in accordance with the instruction, may cause harmful interference to radio communications. However, there is no guarantee that interference will not occur in a particular installation. If this equipment does cause harmful interference to radio or television reception, which can be determined by turning the equipment off and on, the user is encouraged to try to correct the interference by one or more of the following measures :

- Reorient or relocate the receiving antenna.
- Increase the separation between the equipment and receiver.
- Connect the equipment into an outlet on a circuit different from that to which the receiver is connected.
- Consult the dealer or an experienced radio/TV technician for help.

This device complies with Part 15 of the FCC Rules. Operation is subject to the following two conditions: (1) this device may not cause harmful interference, and (2) this device must accept any interference received, including interference that may cause undesired operation.

CAUTION ON MODIFICATIONS

To comply with the limits for the Class B digital device, pursuant to Part 15 of the FCC Rules, this device must be installed in computer equipment certified to comply with the Class B limits. All cables used to connect the computer and peripherals must be shielded and grounded. Operation with non-certified computers or non-shielded cables may result in interference to radio or television reception.

Any changes or modifications not expressly approved by the grantee of this device could void the user's authority to operate the equipment.

CE NOTICE

This is a Class B product.

DISCLAIMER

No warranty or representation, either expressed or implied, is made with respect to the contents of this documentation, its quality, performance, merchantability, or fitness for a particular purpose. Information presented in this documentation has been carefully checked for reliability; however, no responsibility is assumed for inaccuracies. The information contained in this documentation is subject to change without notice.

In no event will AVerMedia be liable for direct, indirect, special, incidental, or consequential damages arising out of the use or inability to use this product or documentation, even if advised of the possibility of such damages.

TRADEMARKS

AVerMedia and AVerTV are registered trademarks of AVerMedia TECHNOLOGIES, Inc. IBM PC is a registered trademark of International Business Machines Corporation. Macintosh is a registered trademark of Apple Computer, Inc. Microsoft is a registered trademark and Windows is a trademark of Microsoft Corporation. All other products or corporate names mentioned in this documentation are for identification and explanation purposes only, and may be trademarks or registered trademarks of their respective owners.

COPYRIGHT

© 2002 by AVerMedia TECHNOLOGIES, Inc. All rights reserved. No part of this publication may be reproduced, transmitted, transcribed, stored in a retrieval system, or translated into any language in any form by any means without the written permission of AVerMedia TECHNOLOGIES, Inc.

Contents

Introduction.....	1
<i>What's in the Package</i>	1
The AVerMedia® AVerTV Box Unit.....	2
<i>The Touch Button Control Panel</i>	2
<i>Infrared Sensor</i>	2
<i>Connection Ports</i>	3
Installation and Setup.....	4
<i>Connecting the VGA monitor or LCD Projector</i>	5
<i>Connecting the Computer</i>	5
<i>Connecting the Antenna</i>	6
<i>Connecting an Audio Cable</i>	6
<i>Connecting the External Amplified Speaker</i>	6
<i>Connecting the Power Adapter</i>	6
<i>Connecting a Video Source</i>	7
<i>Composite Video</i>	7
<i>S-Video</i>	6
<i>Connecting to a Video Output Device</i>	7
Using the AVerMedia® AVerTV Box.....	8
<i>Using AVerMedia® AVerTV Box for the First Time</i>	8
<i>Accessing TV Controls</i>	8
<i>The Remote Control</i>	8
<i>Calling Up a Menu Display</i>	9
<i>TV Source</i>	10
<i>CH Finetune</i>	10
<i>CH Scan</i>	10
<i>Clock</i>	11
<i>More</i>	11
<i>Default</i>	11
<i>Favorite CH</i>	12
<i>Set Area</i>	12
<i>OSD Positioning</i>	13
<i>Resolution</i>	13
<i>Language</i>	13
Customizing the Picture Setting.....	13
Using Teletext (option).....	14
<i>Teletext Control Buttons</i>	14
<i>Viewing Teletext</i>	14
<i>Selecting a Teletext Page</i>	15
LIMITED WARRANTY.....	16

Introduction

Thank you for purchasing the AVerMedia® AVerTV Box3!

With the AVerMedia® AVerTV Box3, you can turn your VGA monitor or LCD projector into a TV with or without even having to turn on your computer. Just plug it into your monitor or LCD projector and you're ready to watch TV or play video games. AVerTV Box3 is completely plug-n-play. There is no software driver required.

What's in the Package

Your AVerMedia® AVerTV Box3 package contains the following items:

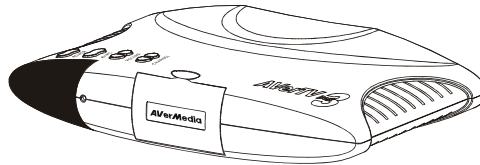

AVerMedia® AVerTV Box3

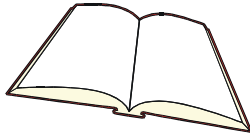

This User's Manual



Vertical Stand



Remote Control
(with batteries)



Power Adaptor



Audio Cable



VGA Cable

The AVerMedia® AVerTV Box3 Unit

Touch Button Control Panel

The Touch Button Panel found on the top side of the AVerTV Box3 provides quick access to commonly used functions.

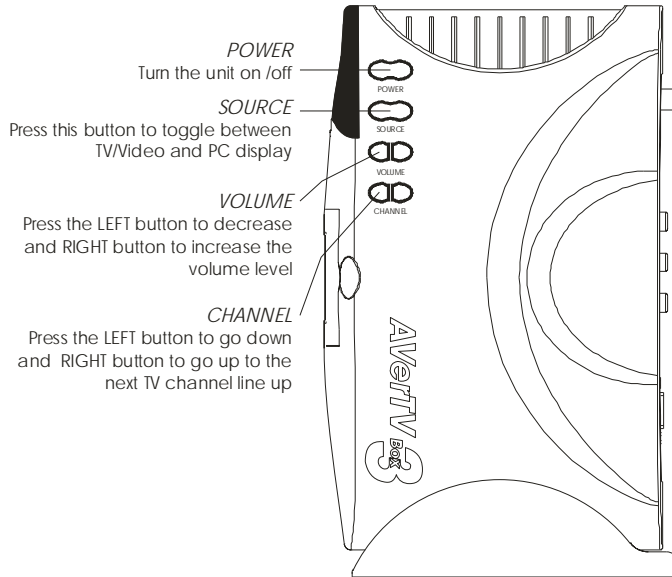

Infrared Sensor

When using the remote control, aim it at the Infrared Sensor which is located at the front panel of the AVerTV Box3.

INFRARED REMOTE SENSOR

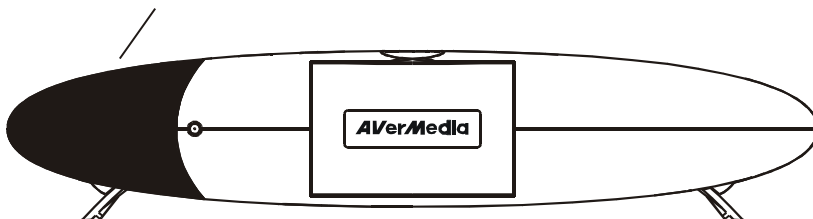

Connection Ports

The port connectors allow connection of your TV antenna, PC, VGA monitor or LCD projector, speakers, video, or s-video source etc.

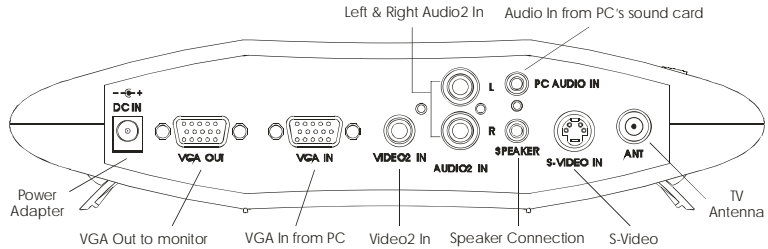

AVerMedia AVerTV Box3 Back Panel

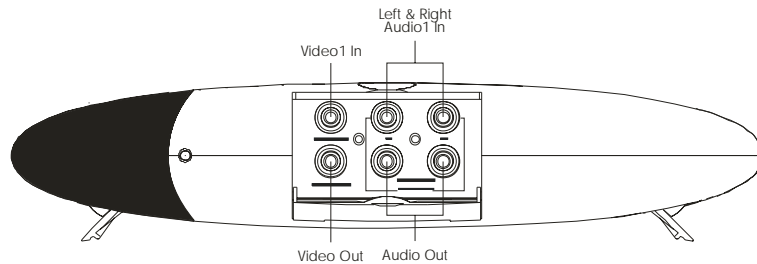

AVerMedia AVerTV Box3 Front Panel

The Installation and Setup section provides more information on cable connections.

Installation and Setup

The figure below shows the proper cable connections for installing AVerMedia® AVerTV Box3.

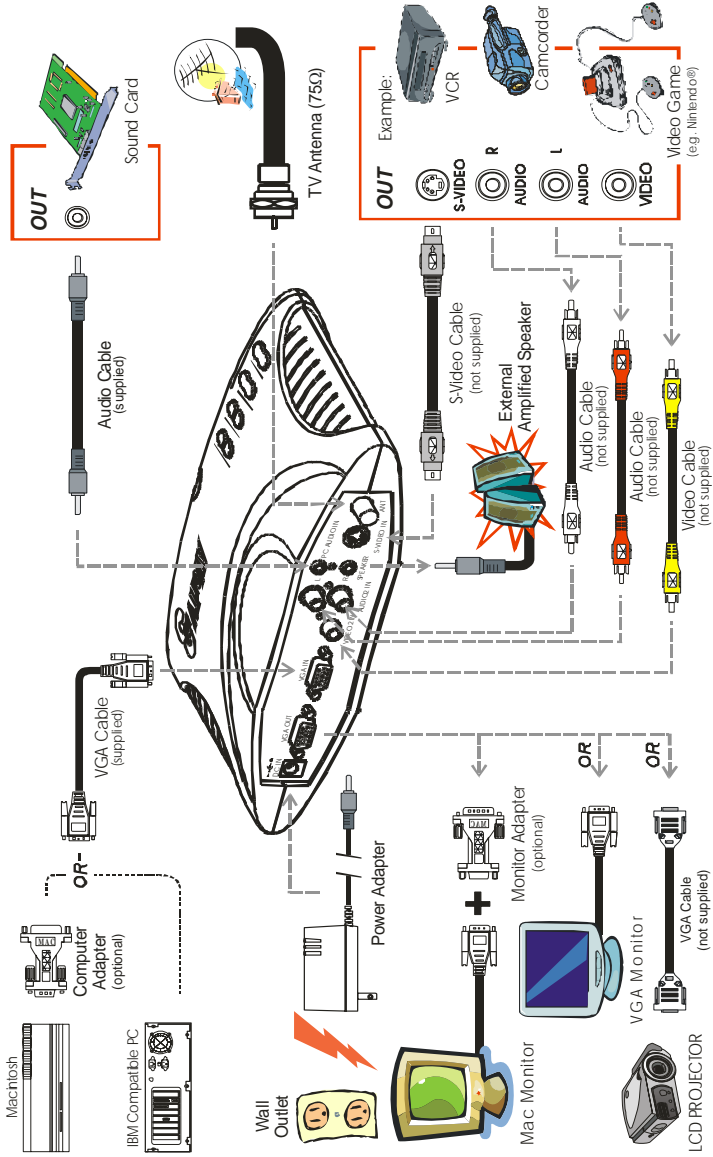

Connecting the VGA monitor or LCD Projector

Connect the monitor cable to the AVerTV Box3 **VGA OUT** port.

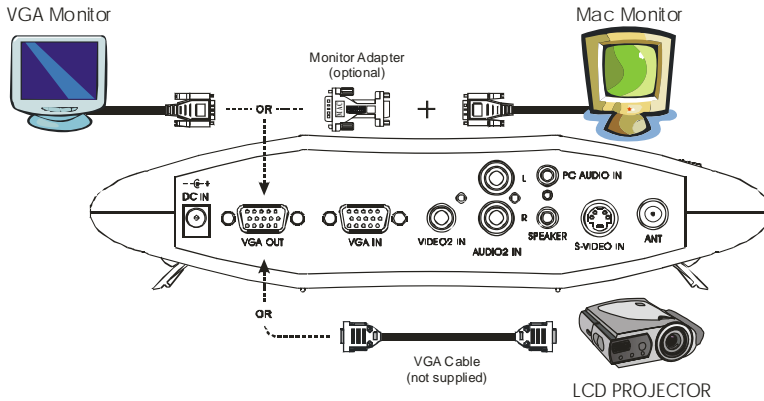

Connecting the Computer

You can use AVerTV Box3 with or without turning the computer on. To switch to PC anytime, connect the supplied VGA cable to the AVerTV Box3 **VGA IN** port and to your computer's VGA card (the terminal where your monitor connects to the PC).

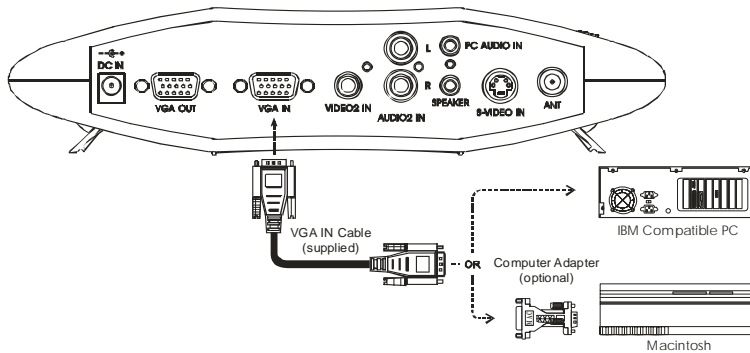

Connecting the Antenna

Attach the antenna or cable TV to the **ANT** port of the AVerTV Box3.

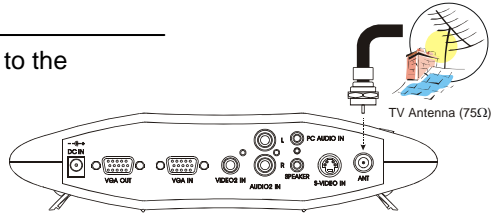

Connecting an Audio Cable

Plug one end of the supplied audio cable to your sound card **LINE OUT (SPEAKER)** port and the other end to the **PC AUDIO IN** port of the AVerTV Box3. This connection allows you to have audio at all times and to adjust the volume from the AVerTV Box3.

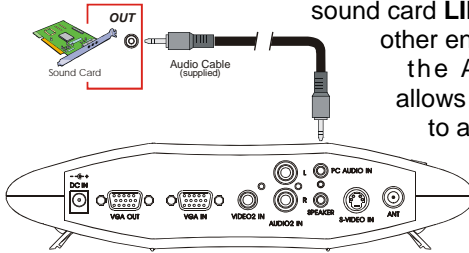

Connecting the External Amplified Speaker

Connect the external amplified speaker to the AVerTV Box3 **SPEAKER** port.

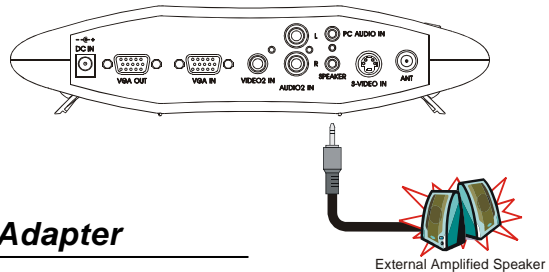

Connecting the Power Adapter

Connect the supplied power adapter to the **DC IN** port of the AVerTV Box3 then plug it into a standard AC power outlet.

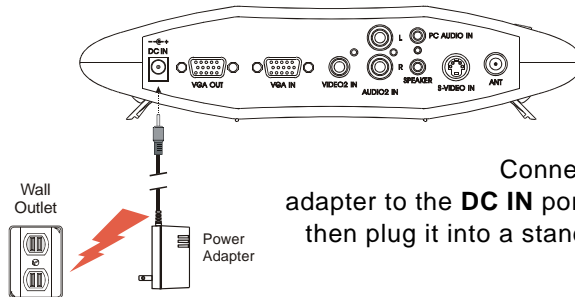

Connecting a Video Source

Composite Video: Connect the video cable (not supplied) to the video out of the video device and to the AVerTV Box3 **VIDEO1 IN** or **VIDEO2 IN** port. Connect the audio cable to the left & right audio out of the video device and to the AVerTV Box3 left & right **AUDIO1 IN** or **AUDIO2 IN** ports.

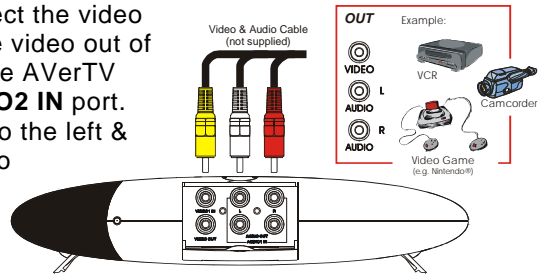

S-Video: Connect the s-video cable (not supplied) to the s-video out of the video device and to the AVerTV Box3 **S-Video IN** port. If your video player supports s-video, use this type of connection as s-video provides better picture quality than composite video.

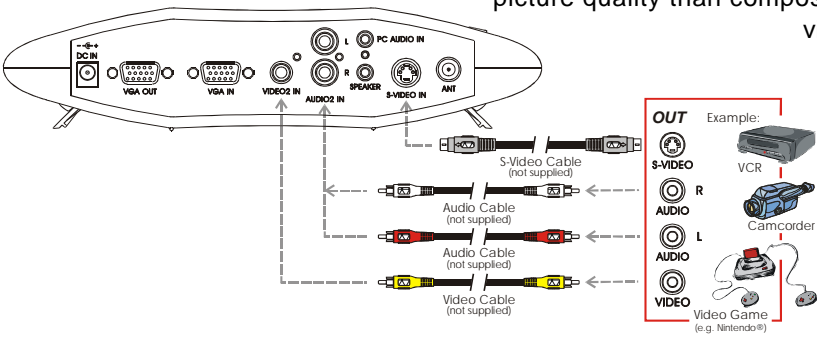

Connecting to a Video Output Device

You can output the video signal from your TV antenna or video source (like the camcorder) to a receiving device. The receiving device can be a VCR, video capture card, etc. Simply connect the receiving device to the AVerTV Box3 **VIDEO OUT** port and left & right **AUDIO OUT** ports.

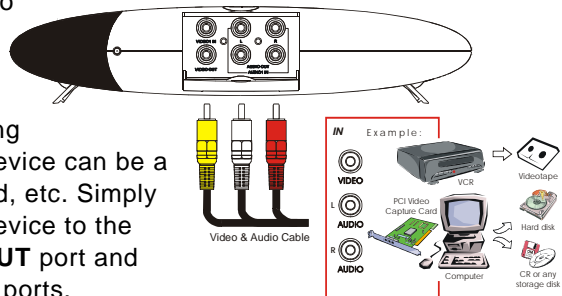

NOTE : The AVerTV Box3 provides composite video output only.

Using the AVerMedia® AVerTV Box3

Using AVerMedia® AVerTV Box3 for the First Time

When you power on the AVerMedia® AVerTV Box3 for the first time, it will automatically proceed to the **SET AREA**. Since TV signals vary in different countries, you need to select the appropriate signal. Refer to the table below for country signals.

NTSC-J	NTSC-M	SECAM-DK	SECAM-L	PAL-I	PAL-BG	PAL-DK
JAPAN	USA-STD	RUSSIA	FRANCE	UK	AUSTRALIA	POLAND-1
	USA-HRC			HK	BANGLADESH	POLAND-2
	USA-IRC				EGYPT	POLAND-3
	TAIWAN				GERMANY	
	KOREA				INDIA	
					ITALY	
					NETHERLANDS_1	
					NETHERLANDS_2	
					RUMANIA	
					SINGAPORE	
					SPAIN	
					SWEDEN	
					UAE	

Each column in the table above corresponds to a different type of TV system. Only one of these TV systems (only one column) will appear as your **SET AREA** the first time you power on the AVerTV Box3. Make sure that you select the correct country signal from the menu.

To ensure that you can select and watch all active channels, refer to the section **CH SCAN** (page 10) on how to automatically scan and memorize all active TV channels in your area.

Accessing TV Controls

To access the various TV controls, open up the menu displays or press on the remote control buttons.

The Remote Control

The figure on the next page shows a clear layout of the remote control unit.

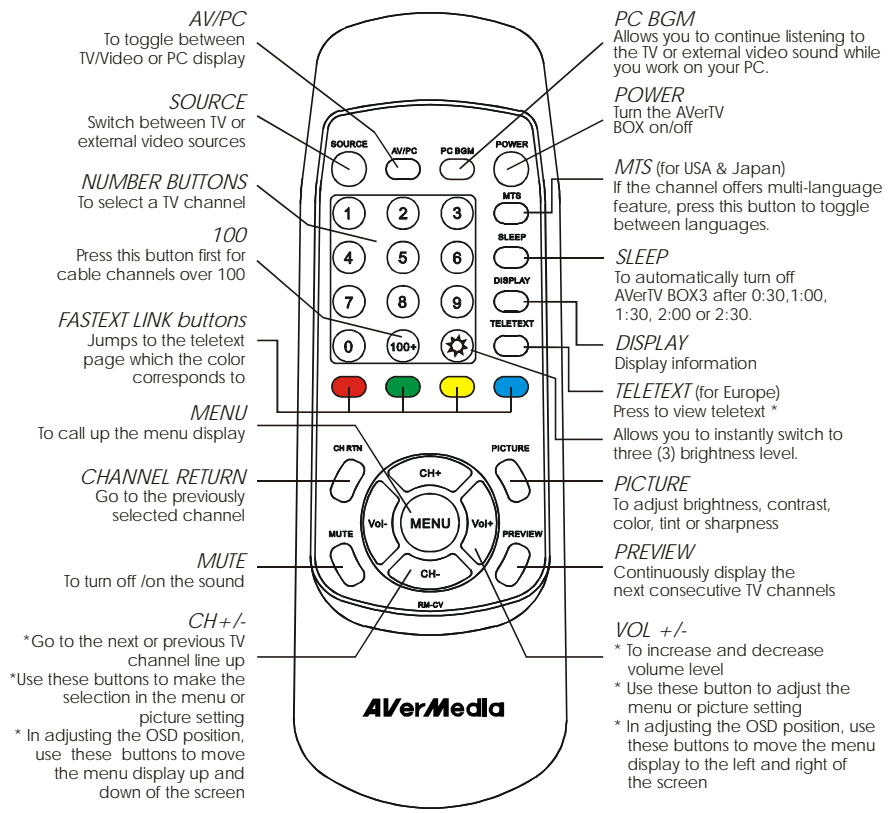





Note: Teletext buttons only present in European model.

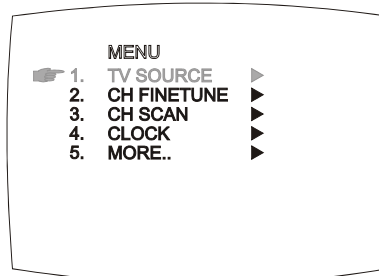

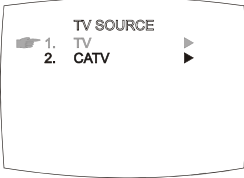
Calling Up a Menu Display

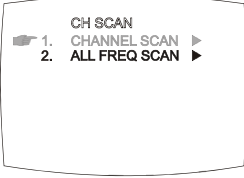

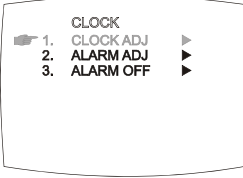

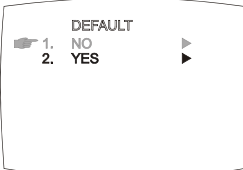
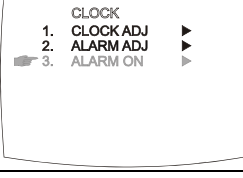
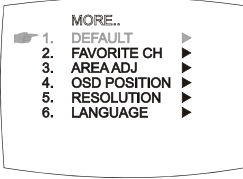
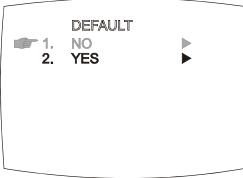
Press the **MENU** button on the remote control to call up and exit from the main menu or sub-menu display. Then, use the **CH+** or **CH-** buttons to select the items in the menu list and use the **Vol+** or **Vol-** buttons to adjust or to make a selection. The table on the next page lists the different functions you will find in the menu.

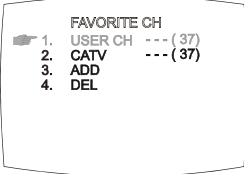

Main Menu	On Screen Display	Usage
TV SOURCE		<p>Use the CH+ or CH- buttons to select between air or cable TV source, then press Vol+ button to make the selection.</p>
CH FINETUNE		<p>If the TV reception is not clear, choose CH FINETUNE then press Vol+ and Vol- buttons until the TV picture becomes clear.</p>
CH SCAN		<p>Use the CH+ or CH- buttons to select between CHANNEL SCAN or All FREQ SCAN, then press Vol+ button to make the selection. If you want to interrupt or cancel the scanning process, press the MENU button but this will only memorize the scanned channel.</p> <p>These two types of channel-preset functions memorize all active channels in your area.</p> <p>Use the CHANNEL SCAN function first. If there are channels missing after you perform CHANNEL SCAN, use the ALL FREQ SCAN function and repeat the searching process.</p> <p>NOTE: ALL FREQ SCAN is a very time consuming process. If the default frequency table already includes all active TV channels in your area, then avoid using the ALL FREQ SCAN.</p>

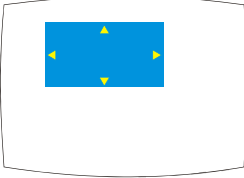
Main Menu	On Screen Display	Usage
CLOCK	 <p>CLOCK</p> <ul style="list-style-type: none"> 1. CLOCK ADJ ▶ 2. ALARM ADJ ▶ 3. ALARM OFF ▶  <p>CLOCK ADJ TIME --:--</p>  <p>ALARM ADJ TIME --:--</p>  <p>CLOCK</p> <ul style="list-style-type: none"> 1. CLOCK ADJ ▶ 2. ALARM ADJ ▶ 3. ALARM ON ▶ 	<p>Use this function to set the clock time and to program the AVerTV Box3 to turn on automatically.</p> <p>The clock and alarm format settings are in "hours : minutes".</p> <p>Simply use the number buttons on the remote to key in the actual time and the time to automatically turn on the AVerTV Box3.</p> <p>If you want to clear or change the time, press Vol-.</p> <p>Under CLOCK menu, select number three (3). Press Vol+ button to select ALARM ON to activate or ALARM OFF to deactivate the alarm function.</p>
MORE..	 <p>MORE..</p> <ul style="list-style-type: none"> 1. DEFAULT ▶ 2. FAVORITE CH ▶ 3. AREA ADJ ▶ 4. OSD POSITION ▶ 5. RESOLUTION ▶ 6. LANGUAGE ▶ 	<p>Press Vol+ button to call up MORE.. menu list.</p>
DEFAULT	 <p>DEFAULT</p> <ul style="list-style-type: none"> 1. NO ▶ 2. YES ▶ 	<p>Use the CH+ or CH- buttons to select YES to clear all the preset channel and to restore to the original factory default picture setting or NO to exit then press Vol+.</p>

Main Menu	On Screen Display	Usage
<p>FAVORITE CH</p>	 <p>FAVORITE CH 1. USER CH --- (37) 2. CATV --- (37) 3. ADD 4. DEL</p>	<p>This function allows you to add, remove and reprogram or reassign the TV channels with the channel numbers that are easier to remember.</p> <p>In the selected USER CH, enter in the new channel number you want to assign or the channel number you want to remove/add in to the channel line up.</p> <p>In the CATV, enter in the channel number you want to remap or the channel number you want to remove/add.</p> <p>Use the CH+ or CH- buttons to select ADD to include or DEL to remove the channel number in the channel line up then press Vol+.</p> <p>Note: To browse through channels while setting the USER CH and CATV number, press the CH+ and CH- buttons.</p>
<p>SET AREA</p>	 <p>SET AREA 1. USA STD ▶ 2. USA HRC ▶▶ 3. USA IRC ▶▶▶ 4. TAIWAN ▶▶▶▶ 5. KOREA ▶▶▶▶▶</p>	<p>When the AVerTV Box3 is first connected, the unit will automatically enter SET AREA menu and allow you to choose the appropriate country signal. Refer to the section, Using the AVerTV Box3 for the First Time, for details (page 8).</p> <p>If you need to enter this mode manually, press the MENU button, select MORE.., select AREA ADJ in the MORE.. menu, use the CH+ or CH- buttons to choose the area selection.</p>

Main Menu	On Screen Display	Usage
OSD POSITION		Use the CH+ , CH- , Vol+ , and Vol- buttons to move the frame on where you want to set the position of the MENU, then press MENU .
RESOLUTION		Use the CH+ or CH- buttons to choose from 640 x 480, 800 x 600 or 1024 x 768 display resolution then press Vol+ .
LANGUAGE	 <p style="text-align: center;">NTSC version</p>  <p style="text-align: center;">PAL and SECAM version</p>	Use the CH+ or CH- buttons to select from different languages then press Vol+ . The available languages for NTSC version are English, 中文 and 영어. For PAL and SECAM, the available languages are English, Español, Deutsch and Français.

Customizing the Picture Setting

If you want to adjust the quality of the TV or video picture, press the **PICTURE** button on the remote. Then, use the **CH+** or **CH-** buttons to select the items in the **PICTURE** menu and use the **Vol+** or **Vol-** buttons to make the adjustment.

To restore the picture default setting, select **RESET** then press **Vol+**.

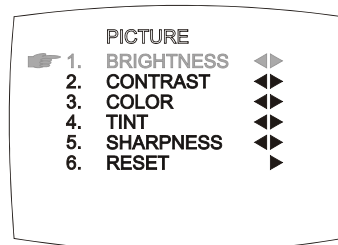

Using Teletext (option)

For European countries, the AVerTV Box3 provides the Teletext function which allows users to receive digital information from TV stations that broadcast such information. Teletext data is widely used in Europe and is transmitted along with normal television programs. The AVerTV Box3 can decode the teletext data and display the resulting information on your computer screen.

TV stations transmit teletext data in pages. Each page takes only a few seconds to update, so you will surely see the very latest information. Teletext pages contain all sorts of information, including the latest news, weather, sports, finance, travel, TV program listings, and more.

Teletext Control Buttons

The figure and descriptions in this section show how to use the teletext function using the remote control.

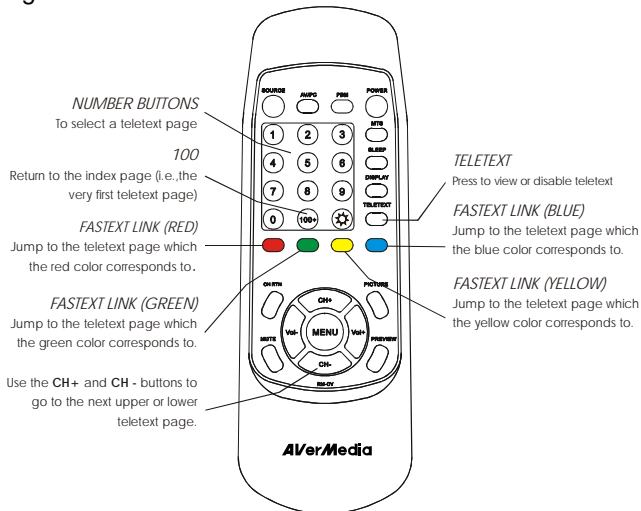

Viewing Teletext

To view teletext information, press the **TELETEXT** button on the remote. Press this button also if you wish to disable teletext.

Selecting a Teletext Page

There are many ways of selecting a teletext page :

- To enter a teletext page number, press on the **NUMBER** buttons 0 ~ 9.
- To view the next upper or lower teletext page, press the **CH+** and **CH-** buttons on the remote.
- To return to the index page (i.e., page 100), press the **100** button.
- To go directly to the next upper or lower 100th page, press the **Vol+** or **Vol-** buttons.

For example :

If you are currently on teletext page 350, you can quickly jump to the next upper 100th page, which is page 400. Just press **Vol+** button.

If you are on teletext page 350, you can quick jump to the next lower 100th page, which is page 300. Press **Vol-** button.

- To select your desired teletext information, use the **FASTTEXT LINK** buttons.

In the last display line of the index page or any teletext page, text appears in four colors : *Red, Green, Yellow, and Blue*. Each color corresponds to a certain teletext information, for example, *Sports*. The **FASTTEXT LINK** buttons allow you to select your desired teletext information and quickly jump to its starting page.

For example :

If Red corresponds to News, press the Red button to jump to the starting page of News.

If Green corresponds to Finance, press the Green button to jump to the starting page of Finance.

If Yellow corresponds to Sports, press the Yellow button to jump to the starting page of Sports.

If Blue corresponds to Travel, press the Blue button to jump to the starting page of Travel.

LIMITED WARRANTY

AVerMedia TECHNOLOGIES, Inc. warrants this product to be free of defects resulting from faulty manufacture or components under the following terms:

WARRANTY LENGTH

Labor is warranted for (1) one year from the date of purchase.

Parts are warranted for (1) one year from the date of purchase.

Replacement products will be warranted for the remainder of the one year warranty period or (30) thirty days, whichever is longer.

WHO IS PROTECTED

This warranty is enforceable only by the first consumer purchaser.

WHAT IS AND IS NOT COVERED

Except as specified below, this warranty covers all defects resulting from faulty manufacturing of this product. The following are not covered by the warranty.

1. Any product on which the serial number has been defaced, modified, or removed.
2. Damage, deterioration, or malfunction resulting from :
 - A. Accident, abuse, misuse, neglect, fire, water, lightning, or other acts of nature, commercial or industrial use, unauthorized product modification, or failure to follow instructions included with the product.
 - B. Misapplication of service by someone other than the manufacturer's representative.
 - C. Any shipment damages. (Claims must be made with carrier.)
 - D. Any other cause which does not relate to a product defect.
3. Cartons, cases, batteries, cabinets, tapes, or accessories used with product.
4. AVerMedia does not warrant that this product will meet your requirements; it is your responsibility to determine the suitability of this product for your purpose.

WHAT WE WILL AND WILL NOT PAY FOR

We will pay labor and material expenses for covered items. However, we will not pay for the following :

1. Removal or installation charges.
2. Shipping charges.
3. Any incidental charges.

EXCLUSION OF DAMAGES

THE MANUFACTURER'S SOLE OBLIGATION AND LIABILITY UNDER THIS WARRANTY IS LIMITED TO THE REPAIR OR REPLACEMENT OF A DEFECTIVE PRODUCT AT OUR OPTION. THE MANUFACTURER SHALL NOT, IN ANY EVENT, BE LIABLE TO THE PURCHASER OR ANY THIRD PARTY FOR ANY INCIDENTAL OR CONSEQUENTIAL DAMAGE (INCLUDING, BUT NOT LIMITED TO, DAMAGES RESULTING FROM INTERRUPTION OF SERVICE AND LOSS OF BUSINESS) OR LIABILITY IN TORT RELATING TO THIS PRODUCT OR RESULTING FROM ITS USE OR POSSESSION.

LIMITATIONS OF IMPLIED WARRANTIES

There are no other oral or written warranties, expressed or implied, including but not limited to those of merchantability or fitness for a particular purpose. Any implied warranties are limited in duration to one year from the date of purchase.

STATE LAW AND YOUR WARRANTY

This warranty gives you specific legal rights, and you may also have other rights granted under state law. These rights vary from state to state.

CONTACT INFORMATION

Web Site: www.aver.com.tw